

*Energy-Saving Demand Ventilation System*

**Installation, Operation and Maintenance Manual**



Your Password  
Protection Code is:

0000



**HOOD  
DEPOT**  
INTL., INC.

Commercial Kitchen Ventilation Products

# CONTENTS

OVERVIEW.....	3
Energy Saving.....	3
Configurations.....	3
System Components.....	3
Regulatory Listings.....	3
Control Panel Touchpad / Button Functions.....	4
Features Definitions.....	5
Fire Emergency Appliance Shutdown.....	5
INSTALLATION.....	6
Unpack and Inventory.....	6
Panel Mounting Location.....	6
Sensor(s) Mounting Location.....	6
ELECTRICAL WIRING... ..	7
Control Panel /System Wiring.....	7
VFD (Variable Frequency Drive) Wiring.....	8
Touchpad Panel Back Wiring.....	8
Control Circuit Wiring.....	9
Fan Wiring to VF Drive.....	9
EFI Duct Sensor Wiring (Single Fan).....	9
Fan Wiring to VF Drive.....	9-10
EFI Duct Sensor Wiring (Multiple Fans).....	10
Wiring Notes.....	10
INITIAL START-UP.....	11
Initial Startup and Programing for Single Exhaust Fan Systems.....	11-12
Initial Startup and Programing for Multiple Exhaust Fan Systems.....	13-14
OPERATION.....	15
Daily Start-up and Routine Operation.....	15
Normal Operation Display.....	15
Shutdown Procedure.....	15
VFD Reset.....	15
Alarms.....	15
Password Protection/ Changing Settings.....	16
Operator Information.....	16
TROUBLE SHOOTING.....	17
Information and Service.....	17
MAINTENANCE.....	18
General Maintenance.....	18
Weekly Quick-Clean.....	18
DOCUMENTATION.....	19
Service Log.....	19
Warranty.....	19
Contact.....	20

## OVERVIEW

The Demand Ventilation System (DVS) automatically matches energy use to the cooking load requirements that vary throughout the day. Unlike conventional systems that waste energy by maintaining peak output regardless of demand, the DVS modulates fans during idle cooking periods, running as low as 50% during off hours to lower the cost of energy use.

## SYSTEM CONFIGURATIONS

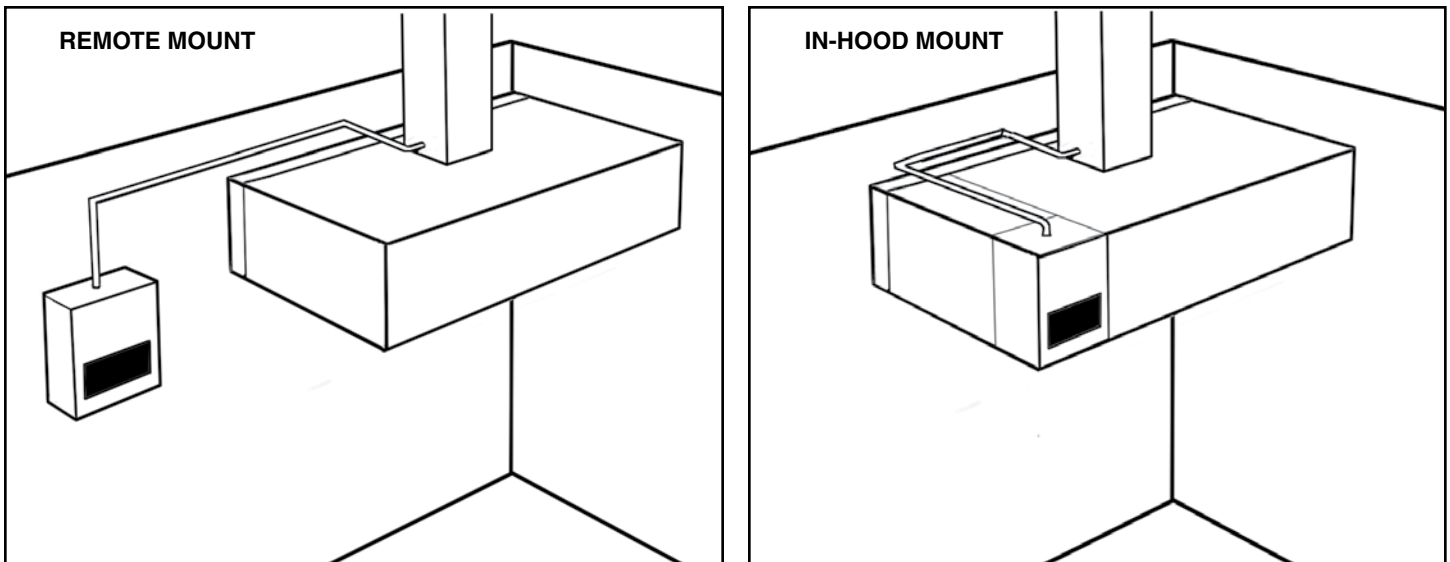

Basic components of the system include the controller/operator interface with internal circuit boards, in-duct temperature sensors, variable frequency drives and system wiring.

Parts list:

1. HD Controller/Operator Interface
2. Variable Frequency Drive (one per fan)
3. Temperature Sensor
4. U.L. Listed Quick Seal
5. Low Voltage High Temp Shielded Wire

Hood Depot's Demand Ventilation System is engineered, manufactured and installed to meet or exceed the listing standard



CONTROL PANEL TOUCHPAD

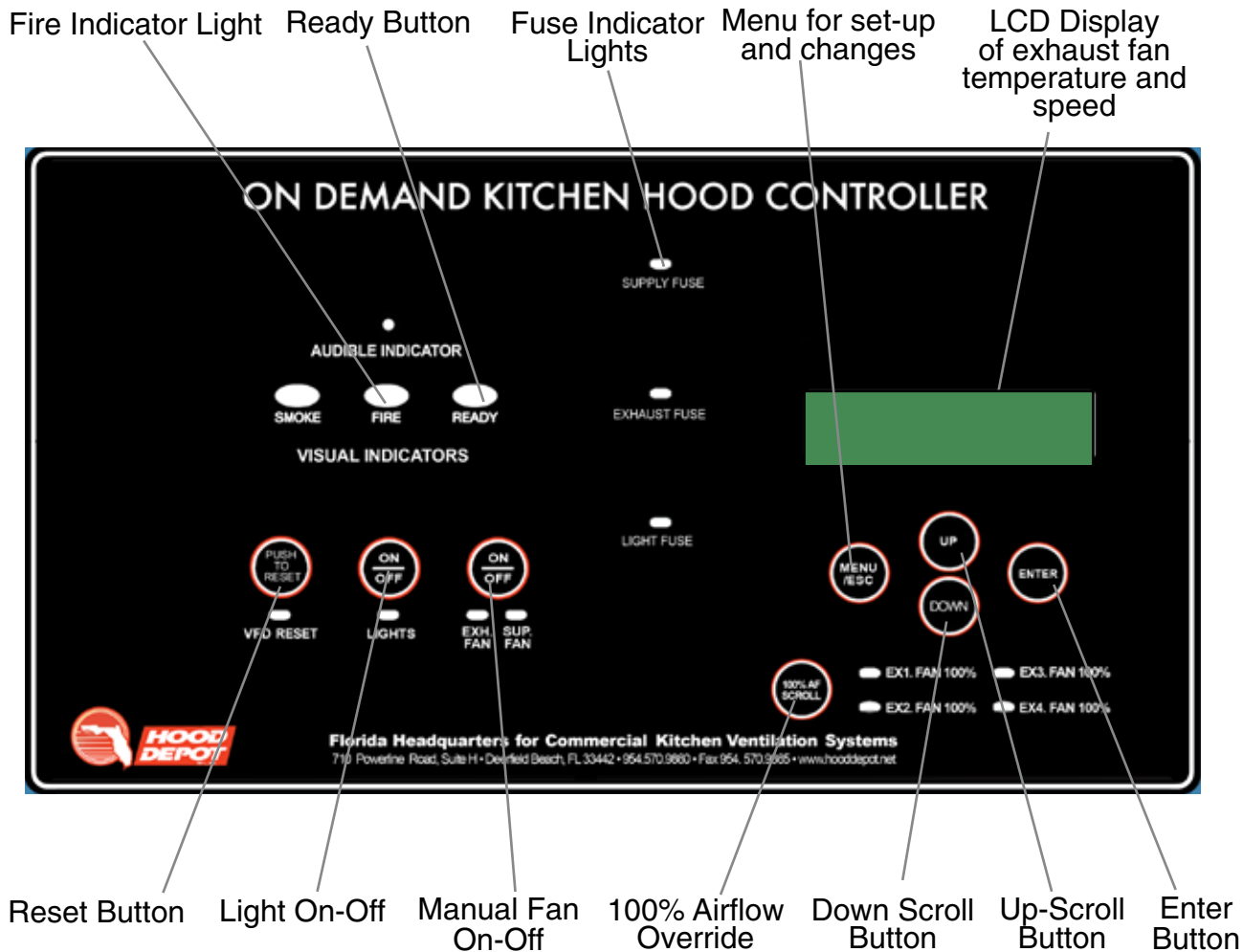

### FEATURES DEFINITIONS

- **Ready Mode** - System is in normal operation and fire system is armed. Green ready LED will be lit. Fans and lights can be operated normally with fan and light touch-buttons.
- **Fire Mode** - Alarm condition, fire system has been activated and red LED is lit. Exhaust fans will run with or without the fan button on; lights will be off with or without light button off. Shunt trip power, horn/strobe power and audible indicator to be activated. Appliance contactor to be deactivated. Supply fans will shut down with or without fan button on.
- **Internal Appliance Contactor** - When the appliance contactor configuration has been set up you can power one 120V 20 amp 1-phase receptacle from the SF1 terminal (it is separately fused). In this configuration, you cannot use the internal 120V supply fan contactor.
- **Light(s) Output** - The lights in the hood need to be wired to the LTS1 terminal. If more than 800 watts are used, then an additional 800 watts can be wired to the LTS2 terminal. If additional lighting loads are needed, the internal appliance contactor can be used for an additional 20 amps.
- **Horn/Strobe** - The touchpad control has audible and visual indicators to meet NFPA 96. In the event that an additional horn or strobe device is required, it can be powered up through the horn/strobe terminal. The device will need to accept 120v 1-phase.
- **AC Drive Output** - The drives will need to be powered on and off and must accept 24v dc. Read your AC drive manual to determine your connection points. Terminal EF24v should be used to power exhaust fan drives and terminal SF24v should be used to power up supply fan drives.
- **Fire System Microswitch** - The fire system microswitch must be wired into the +5v terminal and the fire terminal. The *com* wire of the microswitch needs to be wired into the +5v terminal and the *nc* wire of the microswitch must be wired to the fire terminal. The microswitch's *no* wire is not used.
- **Gas Sensor Input** - An optional gas sensor can be provided to turn on the hood fans if the gas sensor reads a preset level of gas PPM. This assures safety to personnel in case cooking occurs without turning the hoods on. The sensor will have a set of dry contacts and the *com* wire will need to be wired to the 5v terminal while the *no* wire will must be wired to the MISC IN terminal.
- **Temperature Sensor** - To meet IFC and FMC 507.2.1.1, a temperature sensor can be installed in the duct to turn on fans automatically if the temperature rises above a preset level. Once the temperature falls below the setpoint by two degrees, the fans will turn off again.
- **Control Circuit** - Connect your control circuit to the INPUT POWER terminals.

### FIRE EMERGENCY APPLIANCE SHUTDOWN

To meet NFPA 96, 17 and 17A, any receptacle or hard-wired appliance under the hood (or any receptacle outside the hood that feeds an under-hood appliance) must have its power shut down upon activation of the fire system. There are two methods for meeting this code requirement:

**Shunt Trip Output** - Use the shunt terminal to power the shunt trip mechanism of the shunt trip breakers in the circuit panel. An electrician-installed shunt trip breaker is needed for any powered equipment under the hood.

**Internal/External Appliance Contactor** - When the appliance contactor configuration is set up, a 1-phase 120v 20 amp separately fused receptacle can be powered from the SF1 terminal. With this configuration, the 120v supply fan contactor cannot be used. If more than one receptacle is needed (or if power requirement of the receptacle is greater than 120v 1-phase at 20 amps) then you can use this terminal to power up the coils of external appliance contactors. External contactors must be mounted in a separate enclosure and sized for each circuit under the hood. The electrician must bring each circuit into its respective contactor, and then from the load side of the contactor to each receptacle. The contactors will need to be in 'normally open' mode and have a coil voltage of 120v.

# INSTALLATION

## UNPACK & INVENTORY

Upon delivery of the system to your site, immediately inventory all needed parts (see page 3) and check contents for damage; report any damage to the freight carrier. To assist filing of a claim call our customer service at 1 800 322-8730.

## PANEL MOUNTING LOCATION

OPTION 1: If ordered with a new hood and the kitchen layout allows room for a right or left end cabinet, the DVS (Demand Ventilation System) will be mounted as shown:



OPTION 2: If the hood is a retrofit or does not allow the attachment of a cabinet, a Remote DVS wall cabinet will be provided for mounting in a suitable location with sufficient hardware to support the system's weight (mount securely to underlying wall studs).



## SENSOR(S) MOUNTING LOCATION

Sensors are located within the exhaust duct collar, one for each main duct. There can be up to five sensors depending on ventilation system complexity. The sensor is to be located at midpoint through the duct's vertical or horizontal wall, perpendicular to the exhaust flow:

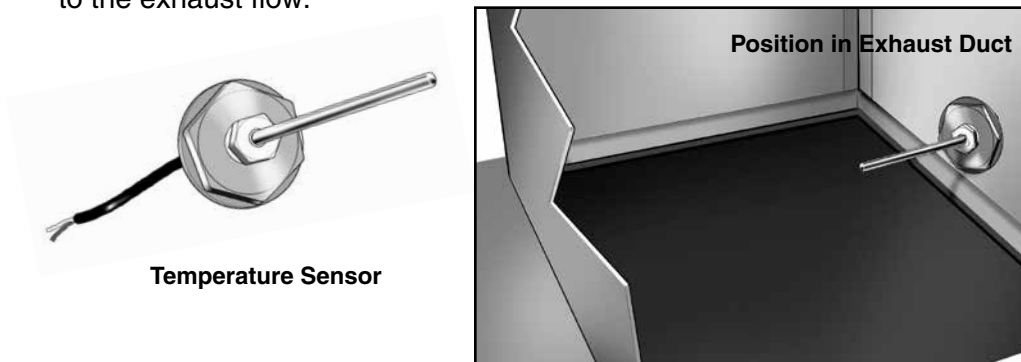

# ELECTRICAL: CONTROL PANEL/SYSTEM WIRING

Example shown is a DVS with one exhaust and one supply

A diagram for your specific application will be provided with your order.

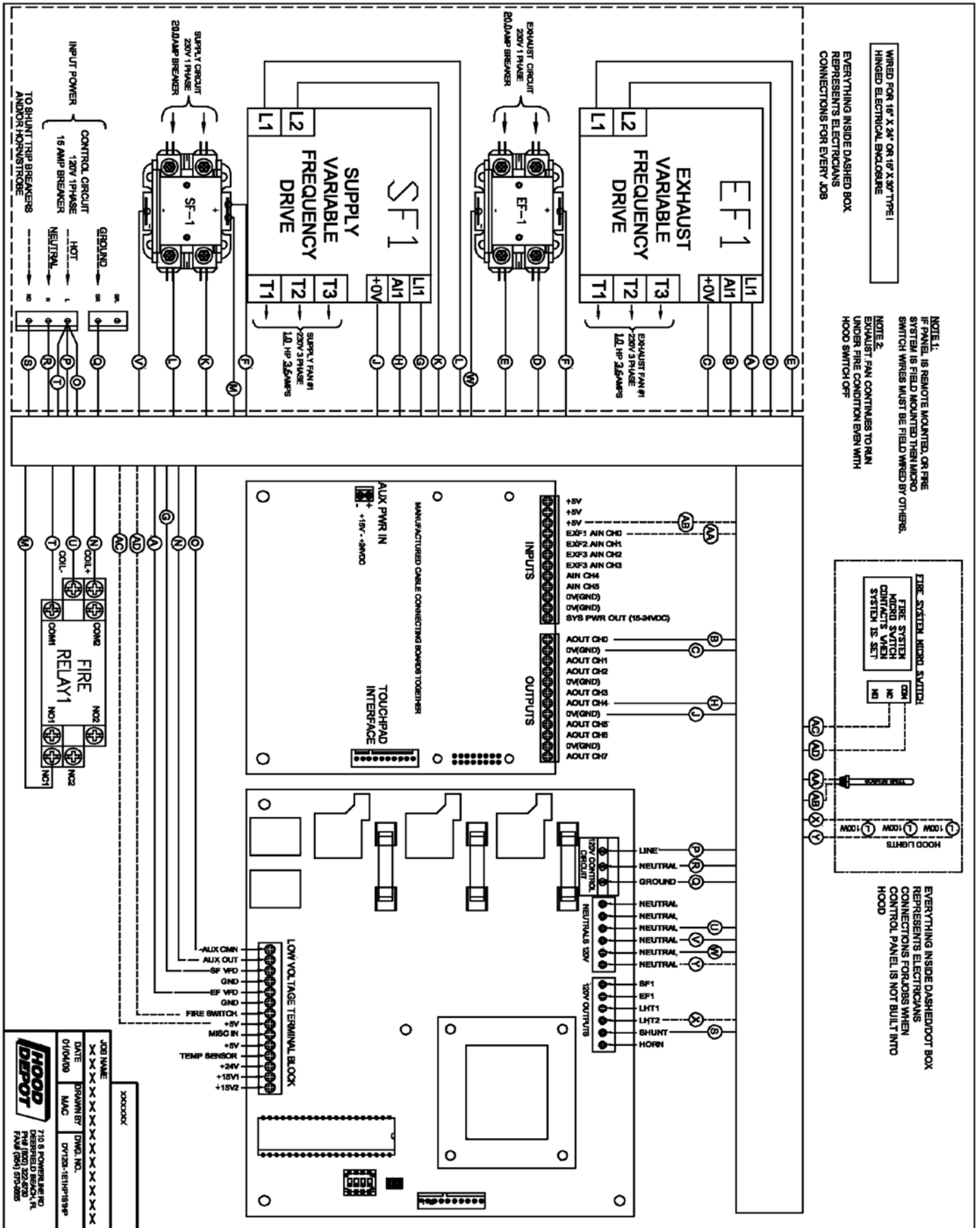

# ELECTRICAL WIRING (Continued)

## VFD WIRING (INSIDE ENCLOSURE)

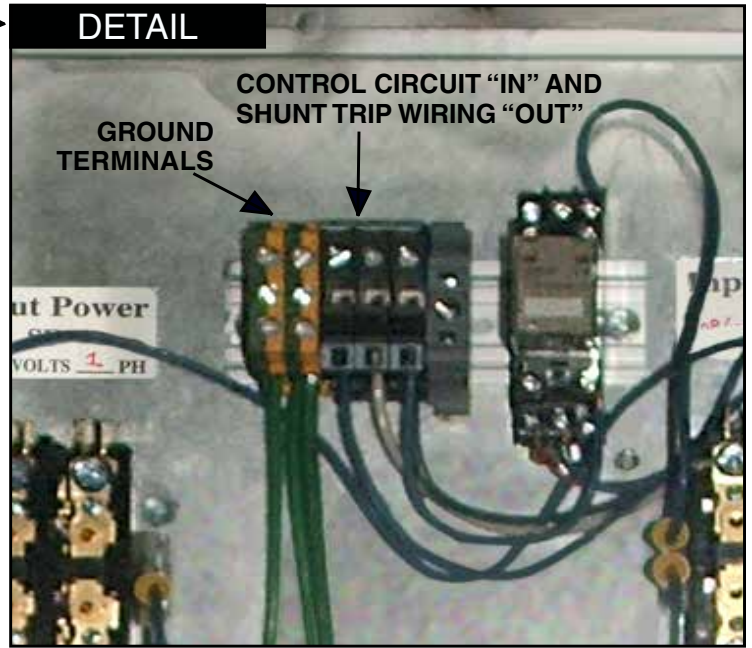

## TOUCHPAD WIRING (BACK OF CONTROLLER)





## ELECTRICAL WIRING (Continued)

### CONTROL CIRCUIT WIRING

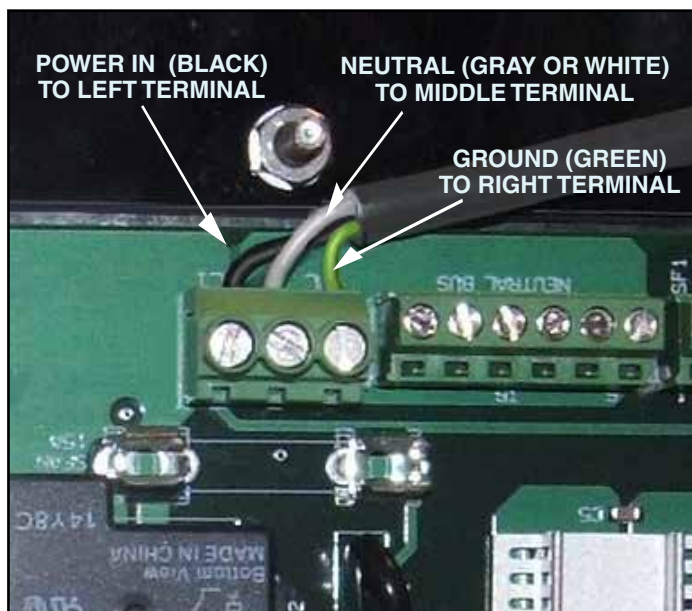

### FAN WIRING (TO VFDs)

Exhaust and Supply fans are controlled by Variable Frequency Drives with power in at top of unit and supplied to fans at bottom.

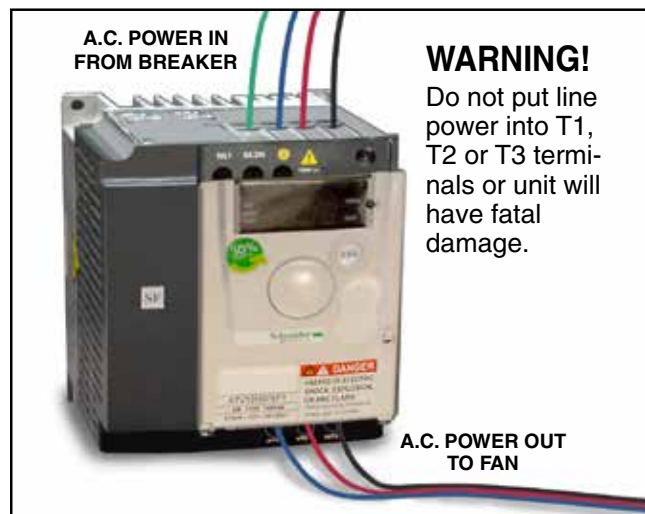

### EFI DUCT SENSOR WIRING (SINGLE SENSOR)

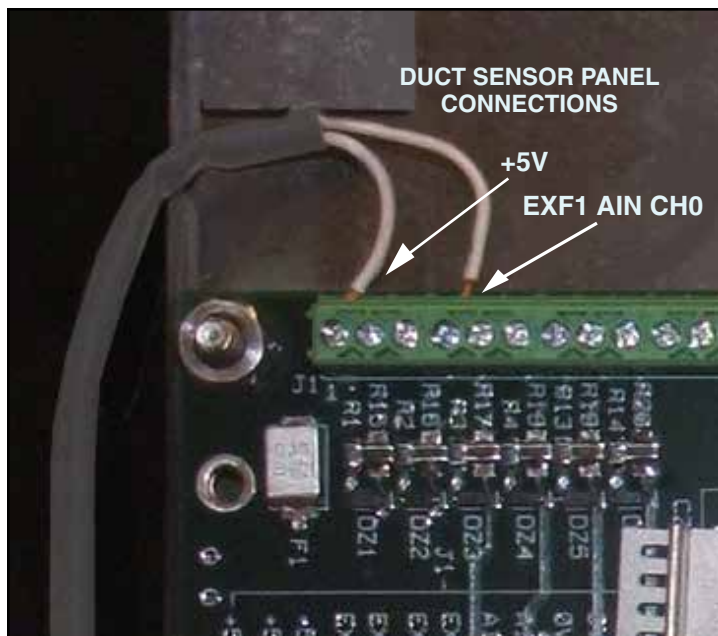

### SENSOR WIRING (TO EXHAUST DUCT)

Sensor is installed in duct connected by j-box; wiring to control unit from j-box is through metal shielded (BX) cable or electrical conduit. Use wire nuts to connect sensor leads to low voltage shielded cabling.



### EFI DUCT SENSOR WIRING FOR MULTIPLE SENSOR SYSTEMS (Next Page)

# INITIAL START UP & PROGRAMMING FOR **SINGLE** EXHAUST FAN SYSTEMS

## START-UP PROCEDURE

**STEP 1:** After installation, confirm circuit breakers are turned on for all exhaust and supply fans as well as the DVS controller. System may then be started up (verify “Ready” light is on). Note: Password code is not needed for initial setup.

**STEP 2 (FOR INITIAL SETUP):** The menu will automatically ask for set-up input; the first prompt is: **Set Low Fan Speed Percentage** using “up” & “down” panel buttons (20% is recommended). Press “Enter”.

```
Enter Ex. Fan % LSP
020%
```

**STEP 3:** Set **Maximum Temperature** according to medium or heavy duty appliance layout demand. Examples: Charbroilers, multiple fryers, woks, upright broilers = Heavy Demand (set to 25°-30° above start temp.); Flat-top griddles, ranges, pasta cookers, single fryer, etc. = Medium Demand (set to 10°-15° above start temp.). Press “Enter”.

```
Enter Temp. Maximum
110°
```

**STEP 4:** Set **Start Temperature** (90° is recommended). Press “Enter”.

```
Enter Start Temp.
090°
```

**STEP 5:** Enter **Fan Percentage Offset** (97% is recommended). Press “Enter”.

```
Enter Fan % Offset
097%
```

## PURPOSE

Preparation for programming touchpad menu

Establishes fan speed 20% slower than design at start temperature.

Example: 1) Start temperature set at 90°  
2) Max temp set to 110°  
3) Exh fan %LSP 030%

When system shows duct temperature at 90° fan will run at 80% of design CFM.

Establishes temperature at which the system performs at 100% speed; accommodates maximum operating temperature according to appliance requirements.

Sets temperature at which system turns on automatically. Adjustable for variations in ambient kitchen start-up temperatures, as in cold climate locations or well cooled kitchen.

Compensates for any VFD drive inaccuracies.

## INITIAL START UP & PROGRAMMING FOR MULTIPLE EXHAUST FAN SYSTEMS

Note: LED Displays shown are before each adjustment

### PURPOSE

Preparation forslah blah opijd iuhjod iirf npeui

**STEP 0:** Olloici ollowit crajafot cgouh fercbilo op lksdf projs solit manuw: Hjkdap ko dddfnoinfoo in noifnoin foiwnf kn cko cillo ceirerog pfpmwffmfmm:

```
Enter Temp Start EF3  
110%
```

**STEP 0:** Olloici ollowit crajafot cgouh fercbilo op lksdf projs solit manuw: Hjkdap ko dddfnoinfoo in noifnoin foiwnf kn cko cillo ceirerog pfpmwffmfmm:

```
Enter Temp Start EF4  
110%
```

**STEP 0:** Olloici ollowit crajafot cgouh fercbilo op lksdf projs solit manuw: Hjkdap ko dddfnoinfoo in noifnoin foiwnf kn cko cillo ceirerog pfpmwffmfmm:

```
Enter Temp Max. EF3  
110%
```

**STEP 0:** Olloici ollowit crajafot cgouh fercbilo op lksdf projs solit manuw: Hjkdap ko dddfnoinfoo in noifnoin foiwnf kn cko cillo ceirerog pfpmwffmfmm:

```
Enter Temp Start EF1  
110%
```

**STEP 0:** Olloici ollowit crajafot cgouh fercbilo op lksdf projs solit manuw: Hjkdap ko dddfnoinfoo in noifnoin foiwnf kn cko cillo ceirerog pfpmwffmfmm:

```
Enter Temp Start EF2  
110%
```

**EFI DUCT SENSOR WIRING CONNECTIONS FOR MULTIPLE SENSOR SYSTEMS**

<b>FAN</b>	<b>OUTPUT CONNECTION</b>	<b>INPUT CONNECTION</b>
#2	+5V	EXF2 AIN CH1
#3	+5V	EXF3 AIN CH2
#4	+5V	EXF4 AIN CH3
#5	+5V	EXF5 AIN CH4

**NOTES ON WIRING:**

- **MAKE SURE** sensor wires are ran and strapped according to NEC, national, state and local codes to meet the requirements of your local AHJ
- **DO NOT** run wires from VFD's next to sensor wires as it can cause noise in the low voltage sensor circuit.
- **DO NOT** bundle high voltage with low voltage (example: 120VAC→5-24VDC)

## INITIAL START UP & PROGRAMMING FOR MULTIPLE EXHAUST FAN SYSTEMS

Note: LED Displays shown are before each adjustment

### PURPOSE

Preparation forslah blah opijd iuhjod iirf npeui

**STEP 0:** Olloici ollowit crajafot cgouh fercbilo op lksdf projs solit manuw: Hjkdap ko dddfnoinfoo in noifnoin foiwnf kn cko cillo ceirerog pfpmwffmfmm:

```
Number of EX. Fans  
004 Fan(s)
```

**STEP 0:** Olloici ollowit crajafot cgouh fercbilo op lksdf projs solit manuw: Hjkdap ko dddfnoinfoo in noifnoin foiwnf kn cko cillo ceirerog pfpmwffmfmm:

```
Number of SP. Fans  
001 Fan(s)
```

**STEP 0:** Olloici ollowit crajafot cgouh fercbilo op lksdf projs solit manuw: Hjkdap ko dddfnoinfoo in noifnoin foiwnf kn cko cillo ceirerog pfpmwffmfmm:

```
Ex. Fan1 map to SF:  
001 Fan
```

**STEP 0:** Olloici ollowit crajafot cgouh fercbilo op lksdf projs solit manuw: Hjkdap ko dddfnoinfoo in noifnoin foiwnf kn cko cillo ceirerog pfpmwffmfmm:

```
Ex. Fan2 map to SF:  
001 Fan
```

**STEP 0:** Olloici ollowit crajafot cgouh fercbilo op lksdf projs solit manuw: Hjkdap ko dddfnoinfoo in noifnoin foiwnf kn cko cillo ceirerog pfpmwffmfmm:

```
Ex. Fan3 map to SF:  
001 Fan
```

## INITIAL START UP & PROGRAMMING FOR MULTIPLE EXHAUST FAN SYSTEMS

### PURPOSE

Note: LED Displays shown are before each adjustment

Preparation forslah blah opijd iuhjod iirf npeui

**STEP 0:** Olloici ollowit crajafot cgouh fercbilo op lksdf projs solit manuw: Hjkdap ko dddfnoinfoo in noifnoin foiwnf kn cko cillo ceirerog pfpmwffmfmm:

```
Ex. Fan4 map to SF:  
001 Fan
```

**STEP 0:** Olloici ollowit crajafot cgouh fercbilo op lksdf projs solit manuw: Hjkdap ko dddfnoinfoo in noifnoin foiwnf kn cko cillo ceirerog pfpmwffmfmm:

```
EF1 to SF1 Ratio  
100%
```

**STEP 0:** Olloici ollowit crajafot cgouh fercbilo op lksdf projs solit manuw: Hjkdap ko dddfnoinfoo in noifnoin foiwnf kn cko cillo ceirerog pfpmwffmfmm:

```
EF2 to SF1 Ratio  
000%
```

**STEP 0:** Olloici ollowit crajafot cgouh fercbilo op lksdf projs solit manuw: Hjkdap ko dddfnoinfoo in noifnoin foiwnf kn cko cillo ceirerog pfpmwffmfmm:

```
EF3 to SF1 Ratio  
000%
```

**STEP 0:** Olloici ollowit crajafot cgouh fercbilo op lksdf projs solit manuw: Hjkdap ko dddfnoinfoo in noifnoin foiwnf kn cko cillo ceirerog pfpmwffmfmm:

```
EF4 to SF1 Ratio  
000%
```

## INITIAL START UP & PROGRAMMING FOR MULTIPLE EXHAUST FAN SYSTEMS

Note: LED Displays shown are before each adjustment

### PURPOSE

In order to forslah blah opijd iuhjod iirf npeui

**STEP 0:** Olloici ollowit crajafot cgouh fercbilo op lksdf projs solit manuw: Hjkdap ko dddfnoinfoo in noifnoin foiwnf kn cko cillo ceirerog pfpmwffmfmm:

```
Enter Temp Max. EF1  
110%
```

**STEP 0:** Olloici ollowit crajafot cgouh fercbilo op lksdf projs solit manuw: Hjkdap ko dddfnoinfoo in noifnoin foiwnf kn cko cillo ceirerog pfpmwffmfmm:

```
Enter Temp Max. EF2  
110%
```

**STEP 0:** Olloici ollowit crajafot cgouh fercbilo op lksdf projs solit manuw: Hjkdap ko dddfnoinfoo in noifnoin foiwnf kn cko cillo ceirerog pfpmwffmfmm:

```
Enter Temp Max. EF3  
110%
```

**STEP 0:** Olloici ollowit crajafot cgouh fercbilo op lksdf projs solit manuw: Hjkdap ko dddfnoinfoo in noifnoin foiwnf kn cko cillo ceirerog pfpmwffmfmm:

```
Enter Temp Max. EF4  
110%
```

**STEP 0:** Olloici ollowit crajafot cgouh fercbilo op lksdf projs solit manuw: Hjkdap ko dddfnoinfoo in noifnoin foiwnf kn cko cillo ceirerog pfpmwffmfmm:

```
Enter Temp Start EF1  
090%
```

**STEP 0:** Olloici ollowit crajafot cgouh fercbilo op lksdf projs solit manuw: Hjkdap ko dddfnoinfoo in noifnoin foiwnf kn cko cillo ceirerog pfpmwffmfmm:

```
Enter Temp Start EF2  
090%
```

## INITIAL START UP & PROGRAMMING FOR **MULTIPLE** EXHAUST FAN SYSTEMS

### PURPOSE

Preparation forslah blah opijd iuhjod iirf npeui

**STEP 0:** Olloici ollowit crajafot cgouh fercbilo op lksdf projs solit manuw: Hjkdap ko dddfnoinfoo in noifnoin foiwnf kn cko cillo ceirerog pfpmwffmfmm:

```
Enter Temp Start EF3  
090%
```

**STEP 0:** Olloici ollowit crajafot cgouh fercbilo op lksdf projs solit manuw: Hjkdap ko dddfnoinfoo in noifnoin foiwnf kn cko cillo ceirerog pfpmwffmfmm:

```
Enter Temp Start EF4  
090%
```

**STEP 0:** Olloici ollowit crajafot cgouh fercbilo op lksdf projs solit manuw: Hjkdap ko dddfnoinfoo in noifnoin foiwnf kn cko cillo ceirerog pfpmwffmfmm:

```
Enter Fan % offset  
100%
```

**STEP 0:** Olloici ollowit crajafot cgouh fercbilo op lksdf projs solit manuw: Hjkdap ko dddfnoinfoo in noifnoin foiwnf kn cko cillo ceirerog pfpmwffmfmm:

```
Enter Auto Off Delay  
001 min
```



**START-UP PROCEDURE**

**PURPOSE**

**STEP 6: System Balance:** After properly performing your initial set-up, press “100% AF SCROLL” to put exhaust and supply fans in 100% mode for 60 minutes to give you time to balance the system at 100%.



Provides a test and balance after installation. This allows technician to force the system into 100% speed in order to adjust fans to the designed cfm. Once the system is balanced it will stay balanced when modulating.

**STEP 7:** For second and subsequent fans, upscroll once for each 10 minutes needed for balancing system. Example: Push upscroll button (below) six times for sixty minutes. For each additional fan (EF2, EF3, EF4, etc.), repeat as above then press “ENTER”.



Provides additional time for balancing multi-fan systems.

## INITIAL START UP & PROGRAMMING FOR **MULTIPLE** EXHAUST FAN SYSTEMS

### START-UP PROCEDURE

**STEP 1:** After installation, confirm circuit breakers are turned on for all exhaust and supply fans as well as the DVS controller. System may then be started up (verify “Ready” light is on). Note: Password code is not needed for initial setup.

**STEP 2:** The menu will automatically ask for set-up input; the first prompt is: **Set Low Fan Speed Percentage** for exhaust fans using “up” & “down” panel buttons (20% is recommended). Press ‘Enter’.

```
Enter Ex. Fan % LSP
020%
```

**STEP 3:** Set **Supply-to-Exhaust Fan Ratios** to determine the percentage of supply air required for each exhaust fan when multiple exhaust fans operate at unequal or differing CFM rates.

*Example: A system with two exhaust fans operating 2000 CFM and 1000 CFM respectively will require supply air allocation (ratio) of 67% and 33%, entered in the display one at a time, first as “EF1/SF Ratio 067%” and next as “EF2/SF Ratio 033%”.*

Specific ratios are determined by the following calculation:

$$\frac{\text{EF1 CFM}}{\text{Total Exhaust CFM}} = \text{EF1 / SF Ratio}$$

```
000%
```

**STEP 4:** Set **Maximum Temperature** according to medium or heavy duty appliance layout demand. *Examples:* Charbroilers, multiple fryers, woks, upright broilers = Heavy Demand (set to 25°-30° above start temp.); Flat-top griddles, ranges, pasta cookers, single fryer, etc. = Medium Demand (set to 10°-15° above start temp.). Press “Enter”.

```
Enter Temp. Maximum
110°
```

*Repeat above* for each fan contained in your system by pressing menu button three times for EF3, four times for EF4, etc. Menu will display each fan in sequence to enter **Temperature Maximum** settings.

### PURPOSE

Preparation for programming touchpad menu

Establishes fan speeds 20% slower than design

Determines percentage of supply air required for each of multiple exhaust fans that have differing CFM operating rates.

Establishes **Maximum Temperature** at which the system performs at 100% speed; accommodates maximum operating temperature according to appliance requirements.

Establishes **Maximum Temperature** for next (e.g., EF2) and subsequent fans in multi-fan system.

## INITIAL START UP & PROGRAMMING FOR MULTIPLE EXHAUST FAN SYSTEMS (Continued)

**STEP 5:** Set **Start Temperature** (90° is recommended). Press “Enter”.



Enter Start Temp.  
090°

Sets temperature at which system turns on automatically. Adjusts for variations in ambient kitchen start-up temperatures, as in cold climate locations or well cooled kitchens.

*Repeat above* to set **Start Temperature** for each fan contained in your multi-fan system.

**STEP 6:** Enter **Fan Percentage Offset** (97% is recommended). Press “Enter”.

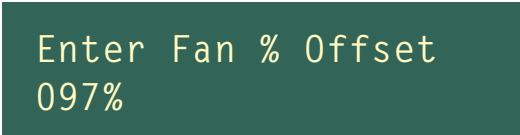

Enter Fan % Offset  
097%

Compensates for any VFD drive inaccuracies.

**STEP 7: System Balance:** After properly performing your initial test and balance of the fans, press “100% AF SCROLL” to put exhaust and supply fans in 100% mode for 60 minutes to give you time to balance the system at 100%.

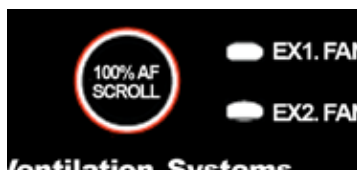

Provides a test and balance after installation. This allows technician to force the system into 100% speed in order to adjust fans to the designed cfm. Once the system is balanced it will stay balanced when modulating.

**STEP 8:** For second and subsequent fans, upscroll once for each 10 minutes needed for balancing system. Example: Push upscroll button (below) six times for sixty minutes. For each additional fan (EF2, EF3, EF4, etc.), repeat as above then press “ENTER”.



Provides additional time for balancing multi-fan systems.

# OPERATION

## DAILY START-UP AND ROUTINE OPERATION

The on-demand system turns on automatically when cooking appliances heat up so there is no need for touchpad operation at morning start-up or at any other time. The “Lights On-Off” button needs to be operated manually.

**NOTE:** It is not necessary to use the fan on-off switch (except for special circumstances) because it overrides the automatic activation program and disables the on-demand system’s automatic turn-off feature if the temperature sensor reads 3° lower than start temperature.

## NORMAL OPERATING DISPLAY

During normal operation the LCD displays as follows:



**NOTE:** When four or more exhaust fans are used, the screen will scroll down every five seconds to show the next fans, displayed three at a time.

## SHUTDOWN PROCEDURE

The ON-Demand system requires no daily shut-down because the system has been programmed (see “Initial Start-Up”) to shut off when heat-generating cooking equipment cools down 3° lower than start temperature. In an emergency, the entire system may be shut down at the breaker box.

## VARIABLE FREQUENCY DRIVE (VFD) RESET

**VFD Reset** is used only to reboot all system VFDs after a ‘Fatal Fault’ occurrence which can include phase loss, high voltage surge or other unusual system interference caused by improper supply power. To address VFD problems, see VFD manufacturer’s manual.

## ALARMS

An **Audio Alarm** sounds to report activation of the fire suppression system (with or without visible fire) and is accompanied by a red indicator light labeled “FIRE” (see page 4).

### PASSWORD PROTECTION / CHANGING SETTINGS

Your unique four-digit pass code is attached to the front of this manual (keep a secure record of this number). It is required only for changing the system settings (i.e., change %LSP, Max Temp, Start Temp, etc.) and is not needed for daily start-up. The system will accept initial set-up programming one time without use of the code.

### OPERATOR INFORMATION

- Once the system has been set up and properly balanced, there is no need to change the display settings except as noted (see “Change Settings”). Changes in cooking schedule, special events, holiday closures, etc., do not require any setting changes to the system. All adjustments are made automatically by the On-Demand System.
- During routine cleaning, do not use caustic cleaners on the surface of the touchpad; wipe with damp cloth. **DO NOT** attempt to clean the interior of the control panel cabinet.
- Do not use pressurized water cleaning devices directly into or behind unit control cabinet or at access door seams.
- Clean and/or replace hood filters according to recommended schedule to keep the system running at top efficiency.
- Do not attempt any electrical changes (e.g., appliance additions or use of alternate receptacles) without consulting the system manufacturer. All electrical work must be performed by a qualified electrician.
- Do not make changes to dampers, windows or any device that may alter kitchen airflow. This will require rebalancing the system.
- Never substitute fuses or any other replaceable part of system with anything other than approved OEM manufacturer’s parts.
- Report any malfunction or unusual noises directly to authorized system supervisor. Do not be alarmed by periods of low noise levels. This is a normal variation automatically made by the on-demand system.

## BASIC TROUBLE SHOOTING

Prior to calling a service company, some minor problems can be overcome by the operator. The following difficulties may not require advanced technical help:

PROBLEM	POSSIBLE CAUSE	REMEDY
<p>Touchpad is operating but one or more fans are not running.</p> <p>Exhaust fan runs but lights and supply fans do not work.</p>	<p>Fatal Fault on VFDs due to phase loss, voltage spike or loss, etc.</p> <p>Fan Belt may need to be replaced.</p> <p>Disconnect-Switch at fan may be off or may need replacement.</p> <p>Motor may need to be replaced.</p> <p>Fire system has been activated.</p> <p>Microswitch for fire system has failed.</p>	<p>Press VFD Reset button on operator interface; allow one minute for system to reset.</p> <p>Check fan belts and replace as necessary.</p> <p>Go to fan(s) and verify that the switch is in "On" position and that power is going into the switch. If power is going into switch but not out (when switch is in "On" position) then replace bad switch.</p> <p>Verify that the non-performing motor is getting proper voltage. If so, replace motor.</p> <p>Verify Ready Light is on at operator interface. If Fire Light (red) is on, call your fire system service company to service your fire system and find the cause of the activation.</p> <p>Have hood service tech verify that 5v coming from the circuit board to the microswitch is returning as 5v to terminal "Fire".</p>
<p>Fans are always running at 100% speed.</p>	<p>Sensor needs to be replaced.</p> <p>Maximum temperature setting is too low.</p>	<p>Check voltage at terminal block(s) AIN CH to verify that circuit has between 0 and 5 volts.</p> <p>Press Menu button and enter password (located on the front of this manual) and press 'Enter' until you see "Enter Temp. Maximum"; increase maximum temperature accordingly.</p>
<p>Fans run all the time.</p>	<p>'Start' temperature setting is set too low.</p>	<p>Press Menu button and enter password (located on the front of this manual) and press 'Enter' until you see "Enter Start Temp."; increase start temperature accordingly.</p> <p>If problem persists due to a fluctuation of space temperature, an optional room temperature sensor can be installed to work out the differential of temperatures between the room and the ducts.</p>
<p>Fans do not extract all smoke and vapors at low speed.</p>	<p>'Low Speed' setting needs to be increased.</p>	<p>Press Menu button and enter password (located on the front of this manual) and press 'Enter' until you see "Enter Ex. Fan% LSP"; Decrease this number so that the low speed is set closer to the design CFM.</p>

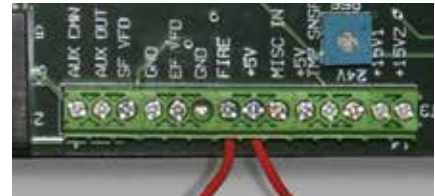

## MAINTENANCE

### GENERAL MAINTENANCE

**SAFETY:** When working on the system, safe practices should be used to eliminate the chance of electric shock. Make sure to use lock-out/tag-out procedure to ensure that nobody turns power on while you are servicing the unit.

**CHECK & ADJUST:** Make sure all bolts, hardware and latches are kept clean and tight; make sure all wiring connections are tight and have not loosened over time.

### WEEKLY QUICK-CLEAN

It is recommended that hood filters be removed and cleaned each week and each duct temperature sensor is wiped clean to assure prompt and accurate response to temperature changes. Do not use caustic cleaning agents.

### CALIBRATION

Recalibration of the system should be done by a factory rep and only when miscalibration is evident to a qualified technician.

**NOTE:** Refer all maintenance questions to our service department at:  
1 800 322-8730



Commercial Kitchen Ventilation Products

**DOCUMENTATION**

**RECORDS LOG**

The following documentation is necessary to maintain warranty and inform service personnel of past service history.

***Note: Service by unauthorized personnel may void warranty***

Date	Service Co.	Service Description	Technician Name	Service Co. Phone



Commercial Kitchen Ventilation Products





Commercial Kitchen Ventilation Products

710 S. Powerline Road, Deerfield Beach, FL 33442 • 954 570-9860 • 800 322-8730 • [www.hooddepot.net](http://www.hooddepot.net)